

QUADRO 45 - MECANISMOS SEMIMONTADOS

DESCRIÇÃO

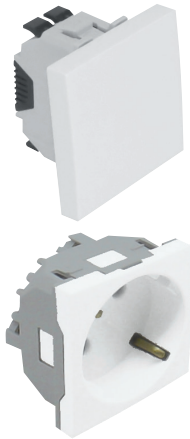

- Aparelhos Semimontados da Série **QUADRO 45** de 1 e 2 módulos.
- Possibilidade de instalação:
  - Embebida (Instalação em caixa de aparelhagem) com acabamento **QUADRO 45** ou **QUADRO 45 - Siza Vieira**.
  - Saliente (Instalação com a Caixa Saliente Modular Q45);
  - Calha Técnica:
    - Calha Molduras (Recurso à Caixa Saliente com adaptação à calha);
    - Calha Distribuição (Recurso ao Adaptador Modular Q45)
- Disponível nas cores **BR** - Branco (RAL 9003), **BM** - Branco Mate, **AL** - Alumina, **PM** - Preto Mate.
- Tomadas de Energia: Simples, duplas e triplas pré-cabadas, disponíveis em 4 cores (Branco, Vermelho, Laranja e Verde).

CARACTERÍSTICAS

- Mecanismos em Termoplástico Técnico - material resistente, não condutor.
- Aparelhos de Comando
  - 10A - 250V~ - ligação por ligadores rápidos. Permite cabo rígido e flexível.
  - Em conformidade com a norma EN 60669-1.
- Tomadas de Energia
  - Tomadas Schuko e Francesa:
    - 16A - 250V~.
    - Ligação por parafusos.
    - Em conformidade com as normas IEC 60884-1; DIN VDE 0620-1 (Schuko) e NF C 61-314 (Francesa).
  - Tomada Euroamericana:
    - 15A - 127V~/16A - 250V~.
    - Em conformidade com as normas ANSI; NEMA WD-6 (Figure 5-15) e IEC 60884-1.
  - Tomada Americana NEMA:
    - 15A - 127V~.
    - Em conformidade com a norma SASO 2204 e NEMA WD-6 (Figure 5-15).

DIMENSÕES (mm)

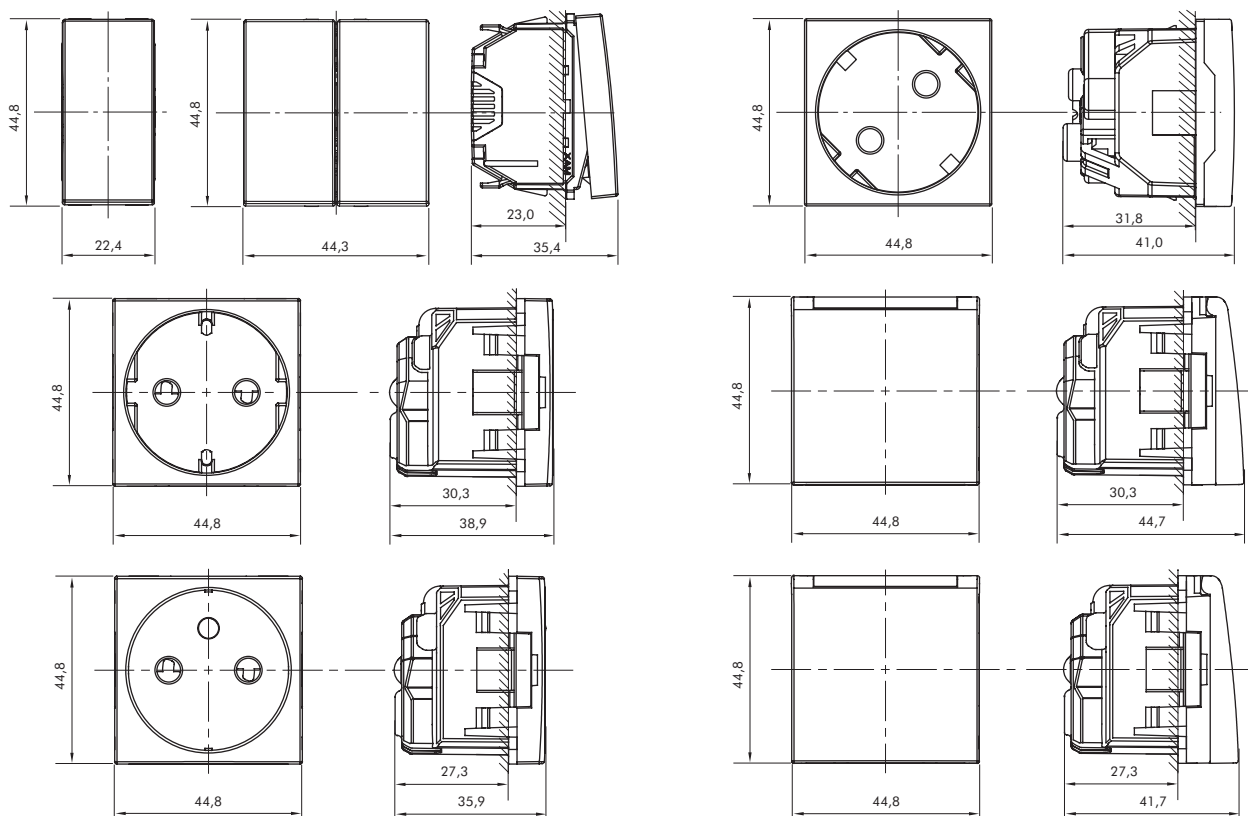

QUADRO 45 - ESQUEMAS DE LIGAÇÃO

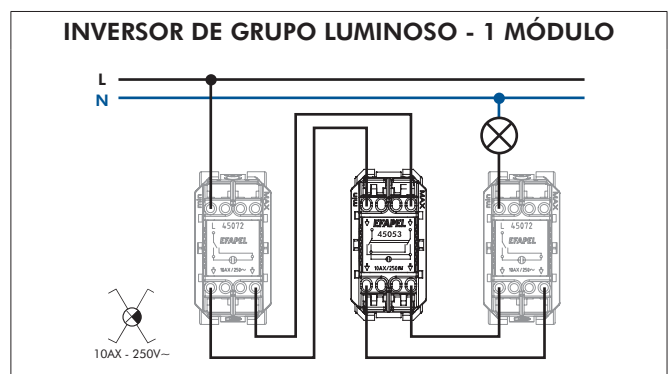
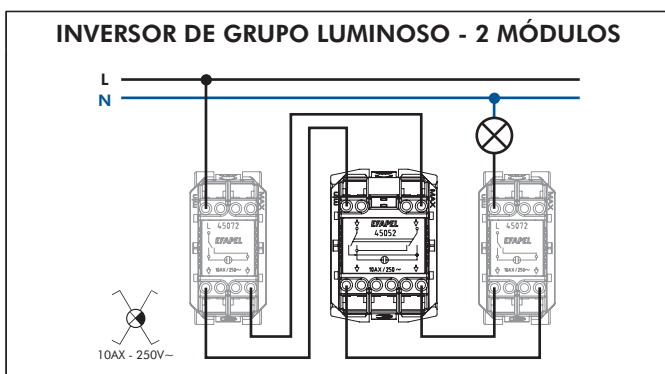
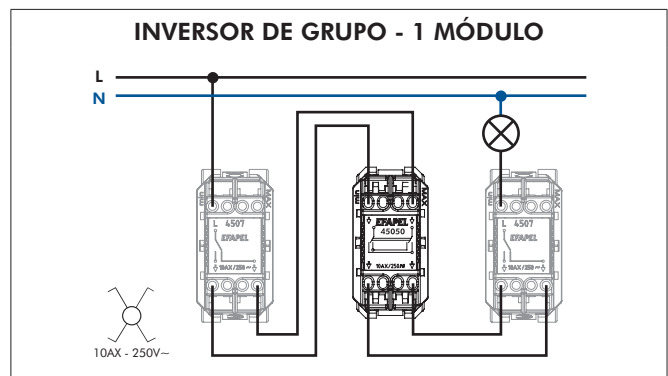
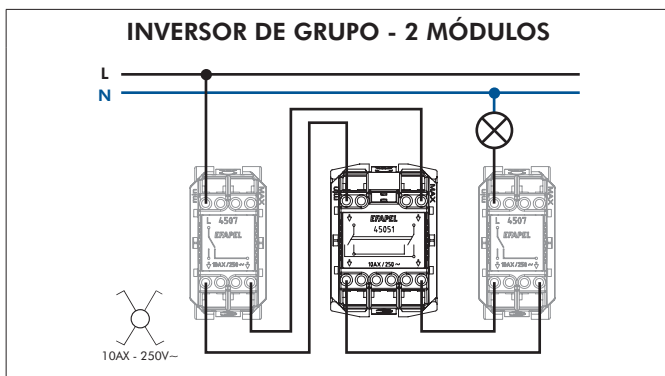
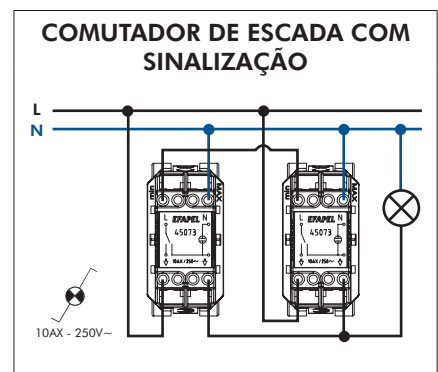
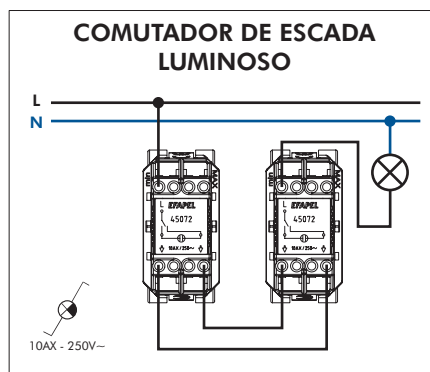
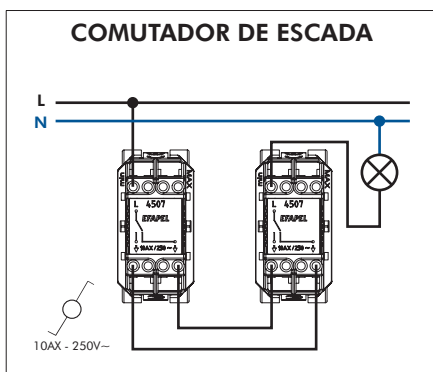
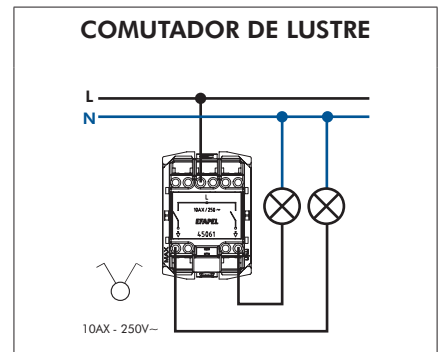
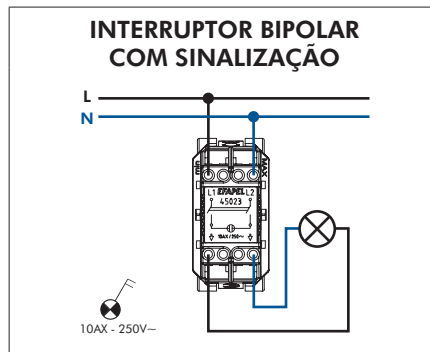
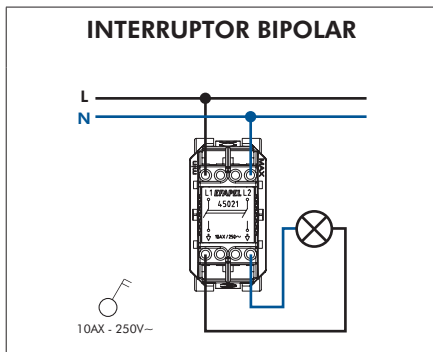
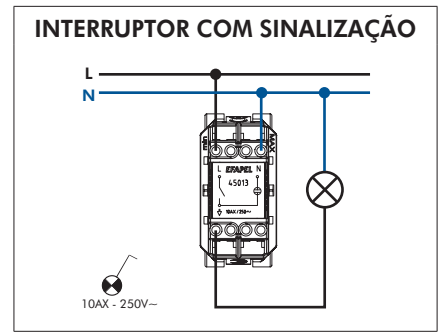
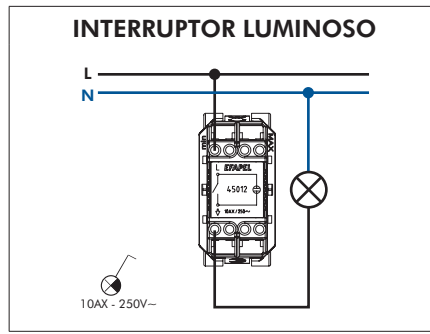
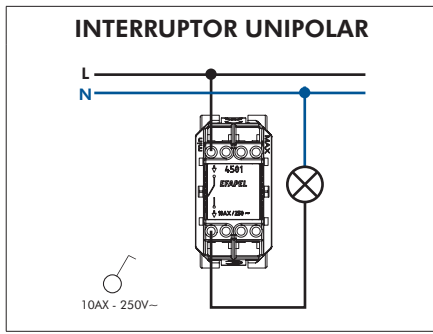

QUADRO 45 - ESQUEMAS DE LIGAÇÃO

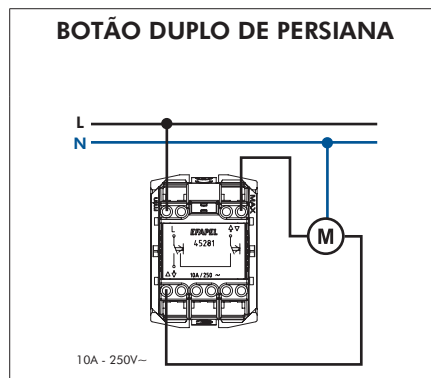
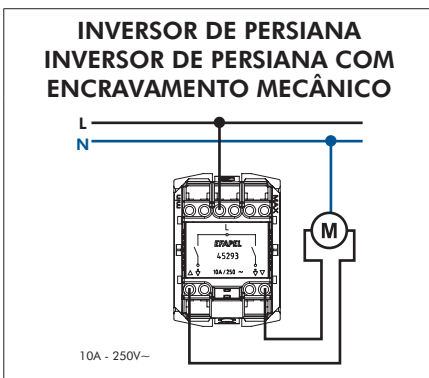
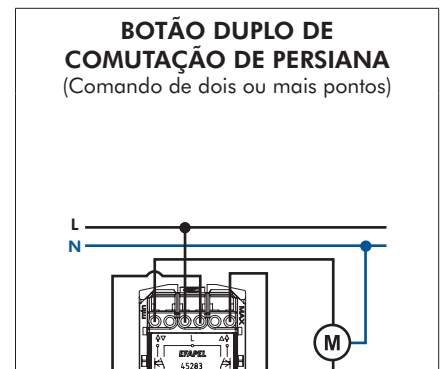
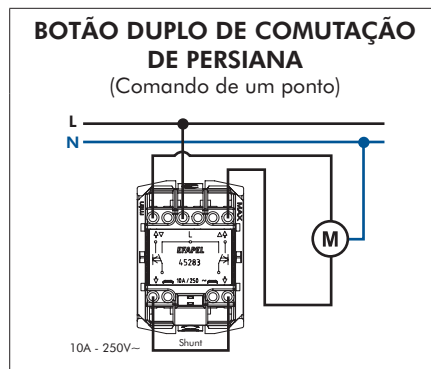
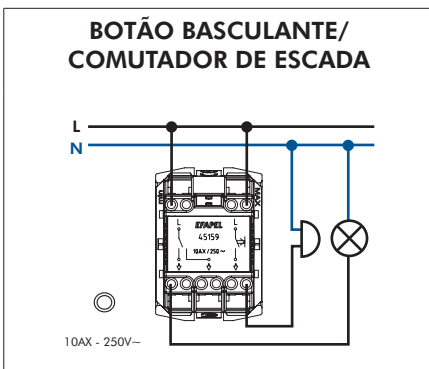
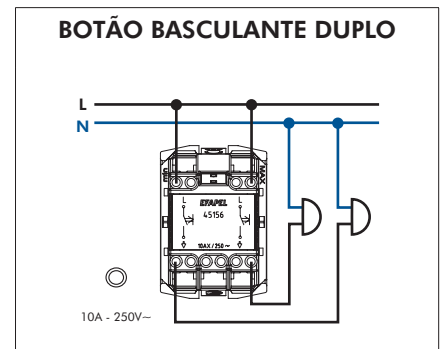
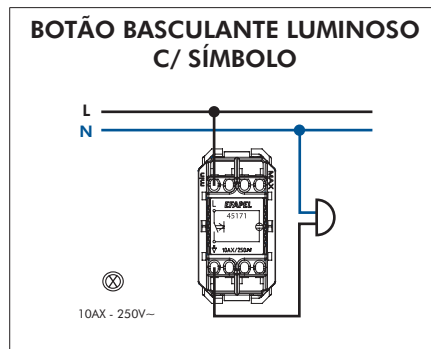
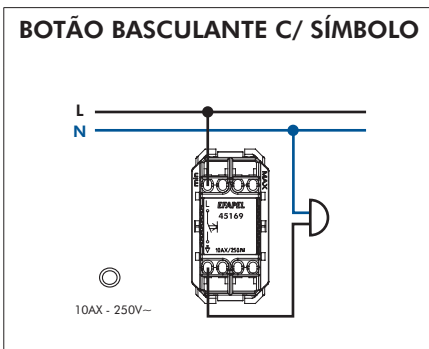
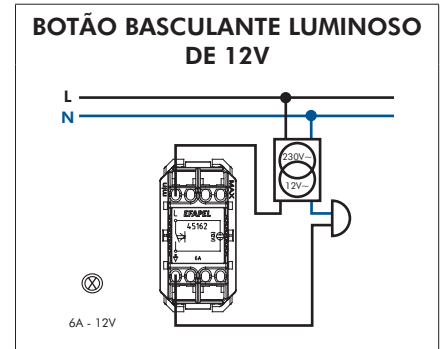
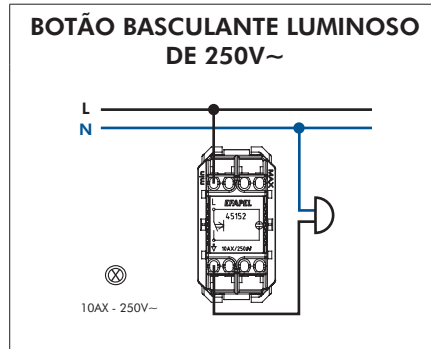
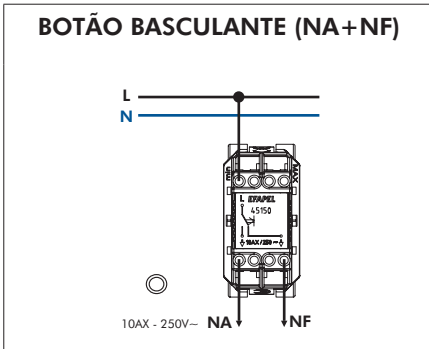
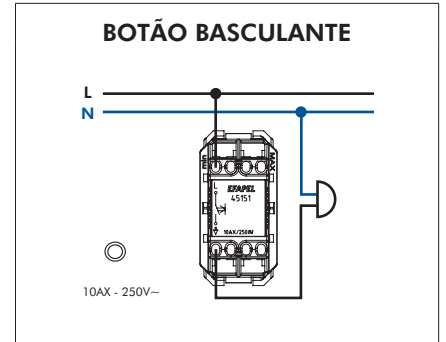
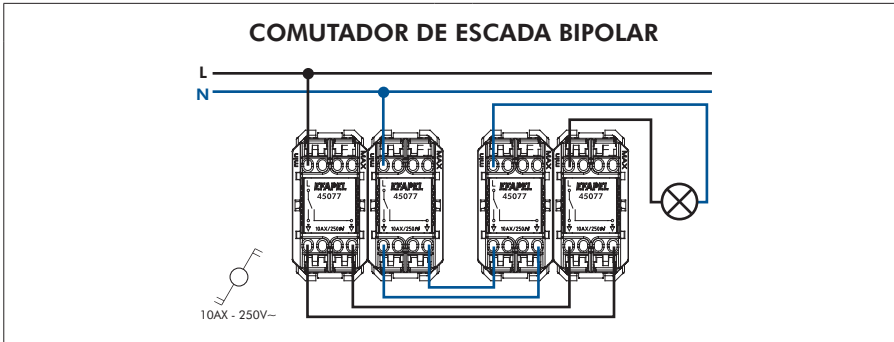

**QUADRO 45**

**SIMPLES**

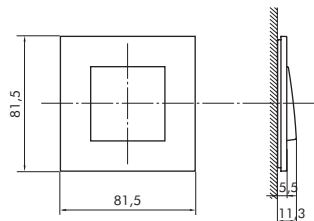

**DUPLO**

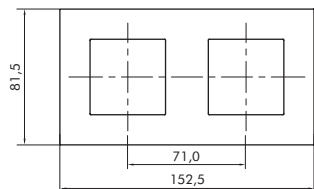

**TRIPLO**

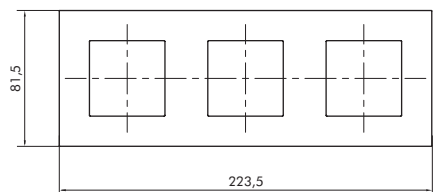

**QUÁDRUPLO**

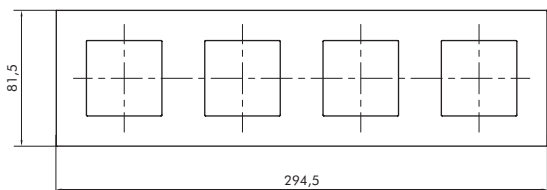

**QUADRO 45**  
Siza Vieira

**SV SIMPLES**

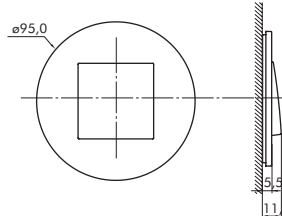

**SV DUPLO**

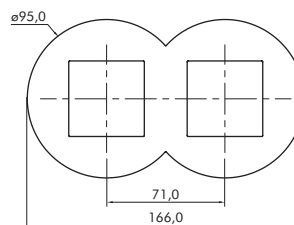

**SV TRIPLO**

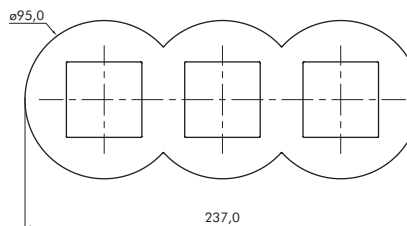

**SV QUÁDRUPLO**

