

Selection diagram

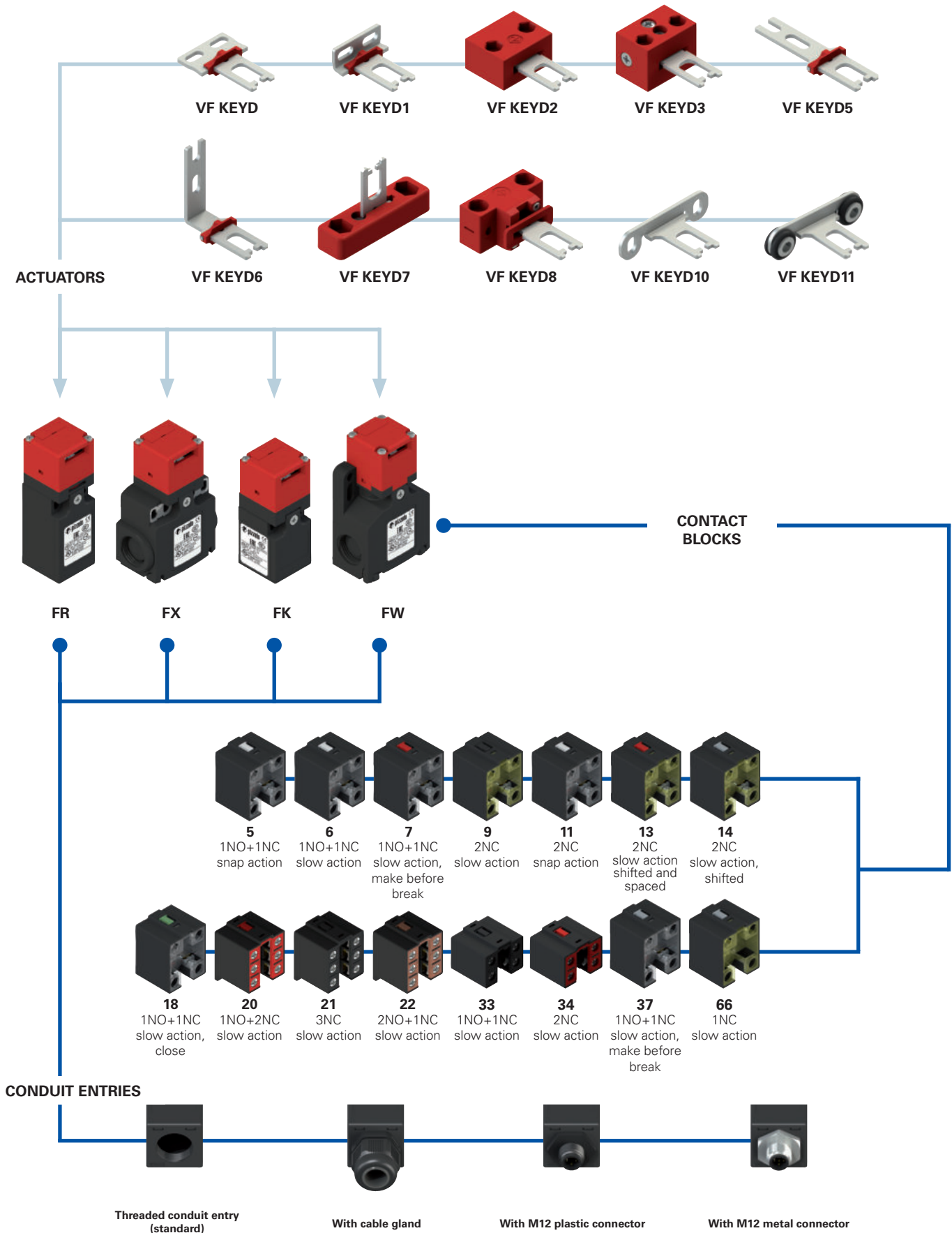

● product option  
 → sold separately as accessory



**Code structure** **Attention!** The feasibility of a code number does not mean the effective availability of a product. Please contact our sales office.

article options options  
**FR 693-E3D1XGM2K70T6**

Housing	
<b>FR</b>	technopolymer, one conduit entry
<b>FX</b>	technopolymer, two conduit entries
<b>FW</b>	technopolymer, three conduit entries

Ambient temperature	
	-25°C ... +80°C (standard)
<b>T6</b>	-40°C ... +80°C

Contact blocks	
<b>5</b>	1NO+1NC, snap action
<b>6</b>	1NO+1NC, slow action
<b>7</b>	1NO+1NC, slow action, make before break
<b>9</b>	2NC, slow action
<b>11</b>	2NC, snap action
<b>13</b>	2NC, slow action, shifted and spaced
<b>14</b>	2NC, slow action, shifted
<b>18</b>	1NO+1NC, slow action, close
<b>20</b>	1NO+2NC, slow action
<b>21</b>	3NC, slow action
<b>22</b>	2NO+1NC, slow action
<b>33</b>	1NO+1NC, slow action
<b>34</b>	2NC, slow action
<b>37</b>	1NO+1NC, slow action, make before break
<b>66</b>	1NC, slow action

Pre-installed cable glands or connectors	
	no cable gland or connector (standard)
<b>K23</b>	cable gland for cables Ø 6 ... 12 mm
...	.....
<b>K70</b>	M12 plastic connector, 4-pole
...	.....

For the complete list of possible combinations please contact our technical department.

Threaded conduit entry	
<b>M2</b>	M20x1.5 (standard)
<b>M1</b>	M16x1.5
	PG 13.5 (FR-FX housing only)
<b>A</b>	PG 11 (FR-FX housing only)

Contact type	
	silver contacts (standard)
<b>G</b>	silver contacts with 1 µm gold coating
<b>G1</b>	silver contacts, 2.5 µm gold coating (not for contact blocks 20, 21, 22, 33, 34)

Head type	
<b>92</b>	detachable head (FW housing only)
<b>93</b>	non-detachable head (FR, FX and FK housing only)

External metallic parts	
	zinc-plated steel (standard)
<b>X</b>	stainless steel

Actuator extraction force	
	10 N (standard)
<b>E3</b>	30 N

Actuators	
	without actuator (standard)
<b>D</b>	straight actuator VF KEYD
<b>D1</b>	angled actuator VF KEYD1
<b>D2</b>	jointed actuator VF KEYD2
...	.....

article options options  
**FK 3393-E3D1XGM1K24T6**

Housing	
<b>FK</b>	technopolymer, one conduit entry

Ambient temperature	
	-25°C ... +80°C (standard)
<b>T6</b>	-40°C ... +80°C

Contact blocks	
<b>33</b>	1NO+1NC, slow action
<b>34</b>	2NC, slow action

Pre-installed cable glands	
	no cable gland (standard)
<b>K24</b>	cable gland for cables Ø 10 ... 5 mm
<b>K28</b>	cable gland for cables Ø 3 ... 7°mm

Actuator extraction force	
	10 N (standard)
<b>E3</b>	30 N

Actuators	
	without actuator (standard)
<b>D</b>	straight actuator VF KEYD
<b>D1</b>	angled actuator VF KEYD1
<b>D2</b>	jointed actuator VF KEYD2
...	.....

Threaded conduit entry	
<b>M1</b>	M16x1.5(standard)
	PG 11

External metallic parts	
	zinc-plated steel (standard)
<b>X</b>	stainless steel

Contact type	
	silver contacts (standard)
<b>G</b>	silver contacts with 1 µm gold coating

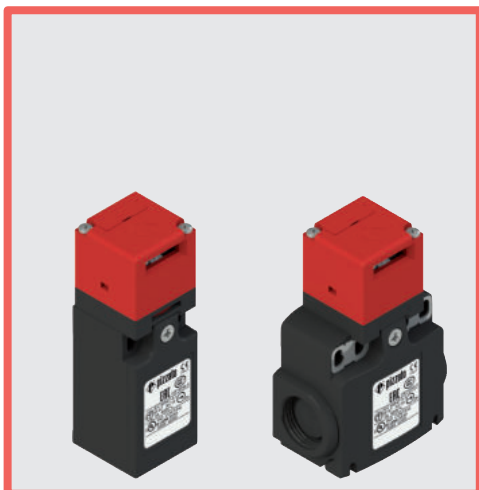

### Main features

- Technopolymer housing, from one to three conduit entries
- Protection degree IP67
- 15 contact blocks available
- 10 stainless steel actuators available
- Versions with M12 connector
- Versions with gold-plated silver contacts

### Quality marks:



IMQ approval:	EG610
UL approval:	E131787
CCC approval:	2007010305230013
EAC approval:	RU C-IT.YT03.B.00035/19

### Technical data

#### Housing

Housing made of glass fibre reinforced technopolymer, self-extinguishing, shock-proof and with double insulation:   
 FR series, one conduit entry: M20x1.5 (standard)   
 FK series: one threaded conduit entry: M16x1.5 (standard)   
 FX series: two knock-out threaded conduit entries: M20x1.5 (standard)   
 FW series: three knock-out threaded conduit entries: M20x1.5 (standard)   
 Protection degree: IP67 acc. to EN 60529 with cable gland of equal or higher protection degree

#### General data

SIL (SIL CL) up to: SIL 3 acc. to EN 62061   
 Performance Level (PL) up to: PL e acc. to EN ISO 13849-1 type 2 acc. to EN ISO 14119   
 Mechanical interlock, coded: low acc. to EN ISO 14119   
 Coding level: low acc. to EN ISO 14119   
 Safety parameter  $B_{10D}$ : 2,000,000 for NC contacts   
 Mission time: 20 years   
 Ambient temperature: -25°C ... +80°C (standard)   
 -40°C ... +80°C (T6 option)   
 Max. actuation frequency: 3600 operating cycles/hour   
 Mechanical endurance: 1 million operating cycles   
 Max. actuation speed: 0.5 m/s   
 Min. actuation speed: 1 mm/s   
 Actuator extraction force: 10 N (-E3 versions: 30 N)   
 Tightening torques for installation: see page 341   
 Wire cross-sections and wire stripping lengths: see page 357

#### In compliance with standards:

IEC 60947-5-1, IEC 60947-1, IEC 60204-1, EN ISO 14119, EN ISO 12100, IEC 60529, EN 50581, BG-GS-ET-15, UL 508, CSA 22.2 No.14

#### Approvals:

EN 60947-5-1, UL 508, CSA 22.2 No.14, GB/T14048.5-2017.

#### Compliance with the requirements of:

Machinery Directive 2006/42/EC, EMC Directive 2014/30/EU, RoHS Directive 2011/65/EU.

#### Positive contact opening in conformity with standards:

IEC 60947-5-1, EN 60947-5-1.

**⚠ If not expressly indicated in this chapter, for correct installation and utilization of all articles see the instructions given on pages 337 to 350.**

### Electrical data

### Utilization category

	Electrical data	Utilization category
without connector	Thermal current ( $I_{th}$ ):	10 A
	Rated insulation voltage ( $U_i$ ):	500 Vac 600 Vdc 400 Vac 500 Vdc (contact blocks 20, 21, 22, 33, 34)
	Rated impulse withstand voltage ( $U_{imp}$ ):	6 kV 4 kV (contact blocks 20, 21, 22, 33, 34)
with M12 connector, 4-pole	Thermal current ( $I_{th}$ ):	4 A
	Rated insulation voltage ( $U_i$ ):	250 Vac 300 Vdc
	Protection against short circuits:	type gG fuse 4 A 500 V
with M12 connector, 8-pole	Thermal current ( $I_{th}$ ):	2 A
	Rated insulation voltage ( $U_i$ ):	30 Vac 36 Vdc
	Protection against short circuits:	type gG fuse 2 A 500 V
	Pollution degree:	3
		Alternating current: AC15 (50±60 Hz)
		$U_e$ (V) 250 400 500
		$I_e$ (A) 6 4 1
		Direct current: DC13
		$U_e$ (V) 24 125 250
		$I_e$ (A) 3 0.55 0.3
		Alternating current: AC15 (50±60 Hz)
		$U_e$ (V) 24 120 250
		$I_e$ (A) 4 4 4
		Direct current: DC13
		$U_e$ (V) 24 125 250
		$I_e$ (A) 3 0.55 0.3
		Alternating current: AC15 (50±60 Hz)
		$U_e$ (V) 24
		$I_e$ (A) 2
		Direct current: DC13
		$U_e$ (V) 24
		$I_e$ (A) 2



## Description



These safety switches are ideal for controlling gates, sliding doors and other guards which protect dangerous parts of machines without inertia. The stainless steel actuator is fastened to the moving part of the guard in such a way that it is separated from the switch each time the guard is opened. A special mechanism ensures that removing the actuator forces the positive opening of the electrical contacts. Easy to install, these switches can be used with all types of guards (with hinge as well as sliding and removable types). The possibility to actuate the switch only with a specific actuator guarantees that the machine can be restarted only after the guard has been closed.

## Head with variable orientation

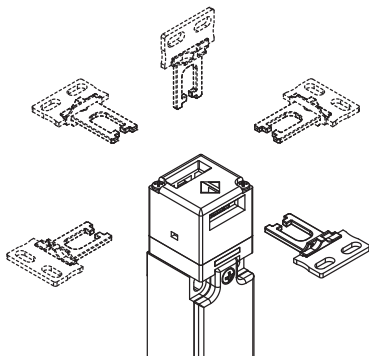

For all switches, the head can be adjusted in 90° steps after removing the two fastening screws. In this way it is possible to actuate the switch from 5 different directions.

## Wide-ranging actuator travel

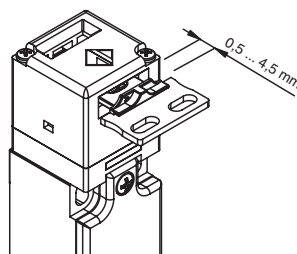

The actuation head of this switch features a wide range of travel. In this way the guard can oscillate along the direction of insertion (4 mm) without causing unwanted machine shut-downs. This wide range of travel is available in all actuators in order to ensure maximum device reliability.

## Not detachable head

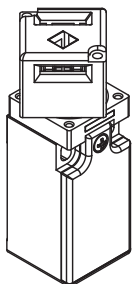

To make head adjustment safer and smoother, these switches are equipped with a special head to body coupling system. This system makes it impossible to remove the head from the device even during adjustment, thus rendering the use of one-way screws unnecessary for locking the head in position once adjustment is complete. This solution is available for the FR, FX and FK series.

## Versions with 30 N actuator extraction force

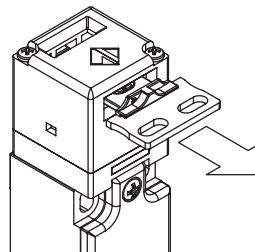

Versions with 30 N actuator holding force instead of the standard 10 N are available.

## Protection degree IP67

# IP67

These devices are designed to be used in the toughest environmental conditions and they pass the IP67 immersion test acc. to EN 60529. They can therefore be used in all environments where maximum protection degree of the housing is required.

## Safety screws for actuators

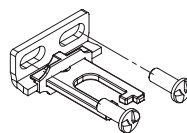

As required by EN ISO 14119, the actuator must be fixed immovably to the guard frame. Pan head safety screws with one-way fitting are available for this purpose. With this screw type, the actuators cannot be removed or tampered by using common tools. See accessories on page 332.

## Extended temperature range

# -40°C

These devices are also available in a special version suitable for an ambient operating temperature range from -40°C up to +80°C.

They can therefore be used for applications in cold stores, sterilisers and other equipment with low temperature environments. The special materials used to produce these versions retain their characteristics even under these conditions, thereby expanding the installation possibilities.

## Features approved by IMQ

Rated insulation voltage (U<sub>i</sub>): 500 Vac  
400 Vac (for contact blocks 20, 21, 22, 33, 34)  
Conventional free air thermal current (I<sub>th</sub>): 10 A  
Protection against short circuits: type aM fuse 10 A 500 V  
Rated impulse withstand voltage (U<sub>imp</sub>): 6 kV 4 kV (for contact blocks 20, 21, 22, 33, 34)  
Protection degree of the housing: IP67  
MV terminals (screw terminals)  
Pollution degree: 3  
Utilization category: AC15  
Operating voltage (U<sub>e</sub>): 400 Vac (50 Hz)  
Operating current (I<sub>e</sub>): 3 A  
Forms of the contact element: Zb, Y+Y, Y+Y+X, Y+Y+Y, Y+X+X  
Positive opening of contacts on contact blocks 5, 6, 7, 9, 11, 13, 14, 18, 20, 21, 22, 33, 34, 66  
In compliance with standards: EN 60947-1, EN 60947-5-1, fundamental requirements of the Low Voltage Directive 2014/35/EU.

Please contact our technical department for the list of approved products.

## Features approved by UL

Electrical Ratings: Q300 pilot duty (69 VA, 125-250 V dc)  
A600 pilot duty (720 VA, 120-600 V ac)  
Environmental Ratings: Types 1, 4X, 12, 13  
Use 60 or 75 °C copper (Cu) conductor and wire size range 12, 14 AWG, stranded or solid. The terminal tightening torque of 7.1 lb in (0.8 Nm).  
The hub is to be connected to the conduit before the hub is connected to the enclosure.

Please contact our technical department for the list of approved products.

		Technopolymer housing Without actuator		Technopolymer housing Without actuator		Technopolymer housing Without actuator		Technopolymer housing Without actuator	
Contact type: <b>R</b> = snap action <b>L</b> = slow action <b>LO</b> = slow action make before break <b>LS</b> = slow action shifted <b>LV</b> = slow action shifted and spaced <b>LA</b> = slow action close									
Contact blocks									
5	<b>R</b>	FR 593-M2	⊕ 1NO+1NC	FX 593-M2	⊕ 1NO+1NC	FW 592-M2	⊕ 1NO+1NC		/
6	<b>L</b>	FR 693-M2	⊕ 1NO+1NC	FX 693-M2	⊕ 1NO+1NC	FW 692-M2	⊕ 1NO+1NC		/
7	<b>LO</b>	FR 793-M2	⊕ 1NO+1NC	FX 793-M2	⊕ 1NO+1NC	FW 792-M2	⊕ 1NO+1NC		/
9	<b>L</b>	FR 993-M2	⊕ 2NC	FX 993-M2	⊕ 2NC	FW 992-M2	⊕ 2NC		/
11	<b>R</b>	FR 1193-M2	⊕ 2NC	FX 1193-M2	⊕ 2NC	FW 1192-M2	⊕ 2NC		/
13	<b>LV</b>	FR 1393-M2	⊕ 2NC	FX 1393-M2	⊕ 2NC	FW 1392-M2	⊕ 2NC		/
14	<b>LS</b>	FR 1493-M2	⊕ 2NC	FX 1493-M2	⊕ 2NC	FW 1492-M2	⊕ 2NC		/
18	<b>LA</b>	FR 1893-M2	⊕ 1NO+1NC	FX 1893-M2	⊕ 1NO+1NC	FW 1892-M2	⊕ 1NO+1NC		/
20	<b>L</b>	FR 2093-M2	⊕ 1NO+2NC	FX 2093-M2	⊕ 1NO+2NC	FW 2092-M2	⊕ 1NO+2NC		/
21	<b>L</b>	FR 2193-M2	⊕ 3NC	FX 2193-M2	⊕ 3NC	FW 2192-M2	⊕ 3NC		/
22	<b>L</b>	FR 2293-M2	⊕ 2NO+1NC	FX 2293-M2	⊕ 2NO+1NC	FW 2292-M2	⊕ 2NO+1NC		/
33	<b>L</b>	FR 3393-M2	⊕ 1NO+1NC	FX 3393-M2	⊕ 1NO+1NC	FW 3392-M2	⊕ 1NO+1NC	FK 3393-M1	⊕ 1NO+1NC
34	<b>L</b>	FR 3493-M2	⊕ 2NC	FX 3493-M2	⊕ 2NC	FW 3492-M2	⊕ 2NC	FK 3493-M1	⊕ 2NC
37	<b>LO</b>	FR 3793-M2	⊕ 1NO+1NC	FX 3793-M2	⊕ 1NO+1NC	FW 3792-M2	⊕ 1NO+1NC		/
66	<b>L</b>	FR 6693-M2	⊕ 1NC	FX 6693-M2	⊕ 1NC	FW 6692-M2	⊕ 1NC		/
Actuating force		10 N (18 N ⊕)		10 N (18 N ⊕)		10 N (18 N ⊕)		10 N (18 N ⊕)	
Travel diagrams		page 344 - group 8		page 344 - group 8		page 344 - group 8		page 344 - group 8	

All switches listed above are available in a version with 30 N actuator extraction force. To obtain these products, the order code must be changed by adding the extension "E3", for example FR 693-M2E3.

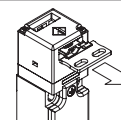

Actuator extraction force: 30 N	30 N (38 N ⊕)	30 N (38 N ⊕)	30 N (38 N ⊕)	30 N (38 N ⊕)

### Limits of use

- Do not use where dust and dirt may penetrate in any way into the head and deposit there. In particular where metal dust, concrete or chemicals are spread.
- Adhere to the EN ISO 14119 requirements regarding low level of coding for interlocks.
- Do not use in environments with presence of explosive or flammable gases or dusts. In these cases use ATEX products (see dedicated Pizzato catalogue).



### Stainless steel actuators

**IMPORTANT:** These actuators can only be used with items of the FR, FX, FK and FW series (e.g. FR 693-M2).  
Low level of coding acc. to EN ISO 14119.

Article	Description
VF KEYD	Straight actuator

Article	Description
VF KEYD1	Angled actuator

Article	Description
VF KEYD2	Jointed actuator

Article	Description
VF KEYD3	Actuator adjustable in two directions

The actuator can flex in four directions for applications where the guard alignment is not precise.

Actuator adjustable in two directions for guards with reduced dimensions.

Article	Description
VF KEYD5	Extended actuator

Article	Description
VF KEYD6	Extended actuator, angled

Article	Description
VF KEYD7	Actuator adjustable in one direction

Actuator adjustable in one direction for guards with reduced dimensions.

Article	Description
VF KEYD8	Universal actuator

Jointed actuator for guards with poor alignment, adjustable in two dimensions for small doors; can be mounted in various positions. The fixing body has two pairs of bore holes; it is provided for rotating the working plane of the actuator by 90°.

Article	Description
VF KEYD10	Profiled actuator

Article	Description
VF KEYD11	Profiled actuator

All values in the drawings are in mm

Accessories See page 321

→ The 2D and 3D files are available at [www.pizzato.com](http://www.pizzato.com)